

PXW-Z100

4K Handheld Memory Camcorder

SONY
make.believe



EINFÜHRUNGSPREIS
EUR 5.235,00
exkl. MWSt.

4K

This handheld camcorder is ready to capture high-quality images with stunning 4K resolution.

The PXW-Z100 uses Exmor R™ CMOS sensor capable of 4K resolution (4096x2160) at 60fps. While weighing under 3kg even with a 4K-compatible high-performance G lens™ mounted.

The recording format is XAVC, which was first used in the PWM-F55 digital cinema camcorder. As with the F55, 4K 60p 4:2:2 10-bit recording is possible at a high bit rate of 600Mbps. QFHD (3840x2160) and HD (1920x1080) resolutions, which have a high compatibility with 4K TV, can also be selected.

Since the PXW-Z100 can be used in the same way as conventional professional handy-type cameras, it's possible to record 4K content with a minimal number of staff. In addition, during editing, downscaling from 4K to HD provides a new workflow for HD content production. The Sony PXW-Z100 is a professional camcorder designed to expand the range of 4K recording possibilities even in low-budget environments.

XDCM™

XAVC

G

Sony Lens G

Exmor R™
CMOS Sensor

XQD™



4K (4096x2160) 60p shooting with a handheld camera

The camcorder provides high sensitivity due to the back-illuminated Exmor R CMOS sensor even in 4K shooting. With 8.8 million effective pixels, the 1/2.3" sensor captures 4K images at 50fps or 60fps. The inbuilt high-performance G Lens offers maximum shooting flexibility, including a wide angle of 30mm in 4096x2160 mode or 31.5mm in 3840x2160 and 1920x1080 modes and 20x powerful optical zoom (equivalent to 35mm).



XAVC format for recording 4K /HD 60p with 4:2:2 10-bit at 600Mbps

The PXW-Z100 uses the XAVC recording format, efficient MPEG-4 AVC/H.264 compression is used for HD (1920x1080), QFHD (3840x2016) and 4K (4096x2160) video. Image sampling is 4:2:2 10-bit, with an intra-frame system that compresses each frame individually at a maximum bit rate of 500Mbps or 600Mbps during 4K 50fps or 60fps recording respectively and 223Mbps during HD 50fps or 60fps recording. The XAVC format is ideal for those looking to implement a high-quality, secure and worry-free workflow.



Update Plan to add LongGOP mode

A free firmware update is planned for the middle of 2014 to support the LongGOP mode for extended 4K recording and to add support for recording with AVCHD, a format that until now has been particularly compatible with the playback environment of Blu-ray Discs.

XQD™ Memory Card as the recording media

Using a PCI Express (expansion bus, serial transfer) interface, the industry standard, an original Sony controller capable of high-speed data processing enables the use of XQD Memory Cards offering the advantage of high write and read speed. Stable recording is possible at a bit rate of 600Mbps.

The PXW-Z100 features two XQD Memory Card slots. Multiple cards can be used in various ways, such as for relay recording. When the first card becomes full, recording continues on the second card without a break.

* The use of new S Series XQD cards (180MB/s transfer speed supported QD-S32E, QD-S64E) is recommended.



High-quality Audio

The PXW-Z100 is equipped with two XLR connectors, which are for professional microphones such as the ECM-680S/MS2/678/674/673/VG1 and wireless microphone systems such as the UWP-V1/V2. By combining the built-in stereo microphone with external microphone input, users can record up to four channels of 24-bit 48-kHz high-quality audio.



HDMI interface for 4K output and 3G HD-SDI interface for HD output

An HDMI is provided for 4K output. When connected to a Sony 4K-compatible BRAVIA TV, an original Sony system enables display of 4K 60p/50p footage. A future firmware upgrade is planned to provide compatibility with the latest HDMI standard (so called HDMI 2.0) and enable 4K 50p/60p output to a wider range of devices. Other features include a 3G HD-SDI interface that supports output to an SDI of up to HD 60p. It also supports HD output during 4K recording.

* Cannot output 4K (HDMI) and HD (3G HD-SDI) simultaneously.



Timecode IN/OUT

The PXW-Z100 comes equipped with Timecode Input/Output connectors. These allow users to synchronize the timecode with other cameras, enabling easier multi-camera productions.

Remote control with WiFi

Focus, zoom and aperture settings and record start/stop can be remote controlled using the browser function of a smartphone.



Paint function for more creative freedom

This enables adjustment of gamma curve, black level, skin detail, color and other parameters that determine image characteristics. Together with other settings, parameter settings can be recorded as a camera profile on a memory card. The recorded camera profile can then be used to set the same parameters in another PXW-Z100 to enable matching of quality and image tones when using a multi-camera setup.

Focus Assist Functions

Various functions are provided to help with precise control of focus. These include Color Peaking, One-push Auto Focus, Focus Magnifier, and the Auto Focus function.

Specifications





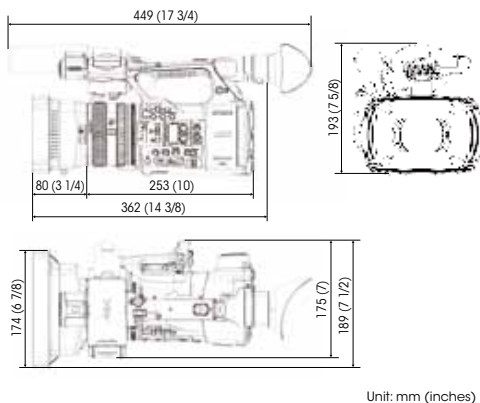

PXW-Z100	
General	
Mass	Approx. 2.46 kg, 5 lb 6.75 oz Approx. 2.91 kg, 6 lb 6.7 oz (with lens hood, eyecup, NP-F970 battery, ECM-XM1 Mic.)
Dimensions (W x H x D)	Approx. 189 x 193 x 362 mm, 7 7/16 x 7 19/32 x 14 1/4 inches (without protrusions)
Power Requirements	7.2 V (battery pack); 12.0 V (AC Adaptor)
Power Consumption	Approx. 14.9 W (while recording, EVF On) Approx. 15.2 W (while recording, LCD monitor On)
Operating Temperature	0°C to 40°C (32°F to 104°F)
Storage Temperature	-20°C to +60°C (-4°F to +140°F)
Battery Operating Time	Approx. 165 mins with NP-F970 battery (while recording, EVF ON, LCD monitor Off)
Recording Format (Video)	XAVC (AVC/H.264 High 4:2:2 Intra Profile VBR)
	XAVC 4K 4096 x 2160 or 3840 x 2160 59.94p: 600 Mbps max, 50p: 500 Mbps max 29.97p: 300 Mbps max, 25p: 250 Mbps max, 23.98p: 240 Mbps max
	XAVC HD 1920 x 1080 59.94p, 50p: 223 Mbps max 29.97p, 25p: 113 Mbps max, 23.98p: 89 Mbps max
Recording Format (Audio)	LPCM 8CH (2CH recording/playback), 24-bit, 48-kHz
Recording/Playback Time (with QD-S64E (64 GB) memory card)	4K 59.94p mode: Approx 10 min 4K 50p mode: Approx 15 min 4K 29.97p mode: Approx 20 min 4K 25p mode: Approx 25 min 4K 23.98p mode: Approx 30 min HD 59.94p, 50p mode: Approx 30 min HD 29.97p, 25p mode: Approx 60 min HD 23.98p mode: Approx 75 min
Lens	
Lens Mount	Fixed
Zoom Ratio	20x (optical), servo/manual
Focal Length	f=4.1 - 82.0 mm equivalent to f=30.0 - 600 mm on 35 mm lens (17:9 4096 x 2160) equivalent to f=31.5 - 630 mm on 35 mm lens (16:9 3840 x 2160, 1920 x 1080)
Iris	F1.6 - F11 auto/manual selectable
Focus	AF/MF selectable, 10 mm to ∞ (Wide), 800 mm to ∞ (Tele)
Image Stabilizer	ON/OFF selectable, shift lens
Filter Diameter	M72 mm
Camera Section	
Imaging Device (Type)	1-chip 1/2.3 type back-illuminated "Exmor R" CMOS Sensor
Imaging Device (Pixel Count)	18.9M (total), 8.8M (effective)
Built-in Optical Filters	OFF: Clear, 1: 1/4ND, 2: 1/16ND, 3: 1/64ND
Minimum Illumination	60P: 4 lux (1/30 Shutter Speed) 50P: 3 lux (1/25 Shutter Speed)

Shutter Speed	1/3 sec to 1/9,000 sec
Slow & Quick Motion Function	1080p: Frame rate selectable 1, 2.4, 8, 15, 30, 60 fps in NTSC mode from 1, 2.3, 6, 12, 25, 50 fps in PAL mode
White Balance	Pre-set (Outdoor: 5600K), A, B
Gain	0, 3, 6, 9, 12, 15, 18, 21, 24, 27 dB, AGC
Gamma Curve	Selectable
Input/Output	
Audio Input	XLR-type 3-pin (female) (x2), line/mic/mic +48 V selectable
Composite Output	Composite Video Out (RCA pin)
Audio Output	RCA pin
SDI Output	BNC (x1), HD/SD selectable
Timecode Input / Output	RCA pin (x1) IN/OUT selectable
USB	mini-B/USB2.0 Hi-speed/mass-storage (x1), Type-A/USB2.0 Hi-speed /Host*1 (x1)
Headphone Output	Stereo mini jack ø3.5 mm (x1)
Speaker Output	Monaural
DC Input	DC jack
Remote	Stereo mini jack ø2.5 mm (x1)
HDMI Output	Type A (x1)
Monitoring	
Viewfinder	0.45-inch type color LCD: 852 [H] x 3 [RGB] x 480 [V], 16:9
Built-in LCD Monitor	3.5-inch type Xtra Fine LCD™: 852 [H] x 480 [V] x 3 [RGB], 16:9
Built-in Microphone	
	Omni-directional stereo electret condenser microphone.
Media	
Type	XQD x2 (for XAVC) Memory Stick Duo™ and SD/SDHC/SDXC compatible x1 (for AVCHD) *AVCHD is planned to be updated in the future SD/SDHC/SDXC x1 (for Utility SD slot)
Supplied Accessories	
	Lens hood (1), Pre-installed to the Camcorder EVF eyecup (1) USB cable (1) AV connecting cable (1) AC-NB12A AC adaptor (1) HDMI Cable (1) Wi-Fi dongle (1) ECM-XM1 Microphone (1) Operating instructions (1) AC Cable (2) Battery Charger (1) NP-F970 Battery (1) Warranty (1) CD-ROM: Operating instructions in PDF (1)

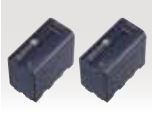
Dimensions



Available Accessories

 2NP-F970/B Rechargeable Battery Pack	 ACC-L1BP AC Adaptor/Charger/Battery Kit	 VCT-PG11RMB Tripod with RM-1BP Remote Controller	 LCS-G1BP Soft Carrying Case	 LCS-BP1BP Soft Carrying Case
 RM-1BP Remote Commander	 QD-S32E/QD-S64E XQD S Series card 32GB / 64GB	 QDA-EX1 XQD ExpressCard Adaptor	 MRW-E80 XQD Card Reader	

Distributed by

pro:media
medien- und studioteknik

Schmiedlstrasse 1, A-8042 Graz / Austria
T: +43 316 475 226-0 F: +43 316 475 226-90
Eyzinggasse 23, A-1110 Wien / Austria
T: +43 1 585 12 74-0 F: +43 1 585 12 74-90
E: info@pro-media.at W: www.pro-media.at

MK1 1076V1 OHB1 3SEP

© 2013 Sony Corporation. All rights reserved.
Reproduction in whole or in part without written permission is prohibited.
Features and specifications are subject to change without notice.
The values for mass and dimension are approximate.
Sony and Sony logo are trademarks of Sony Corporation.
XDCAM, XQD, Memory Stick, XAVC, ExmorR are trademarks of Sony Corporation.
AVCHD and AVCHD logo are trademarks of Panasonic Corporation and Sony Corporation.
Windows is a registered trademark of Microsoft Corporation in the United States and other countries.
Macintosh and Final Cut Pro are trademarks of Apple.
SD, SDHC and SDXC logs are trademarks of SD-3C, LLC.
All other trademarks are the property of their respective owners.